

SECTION B-B

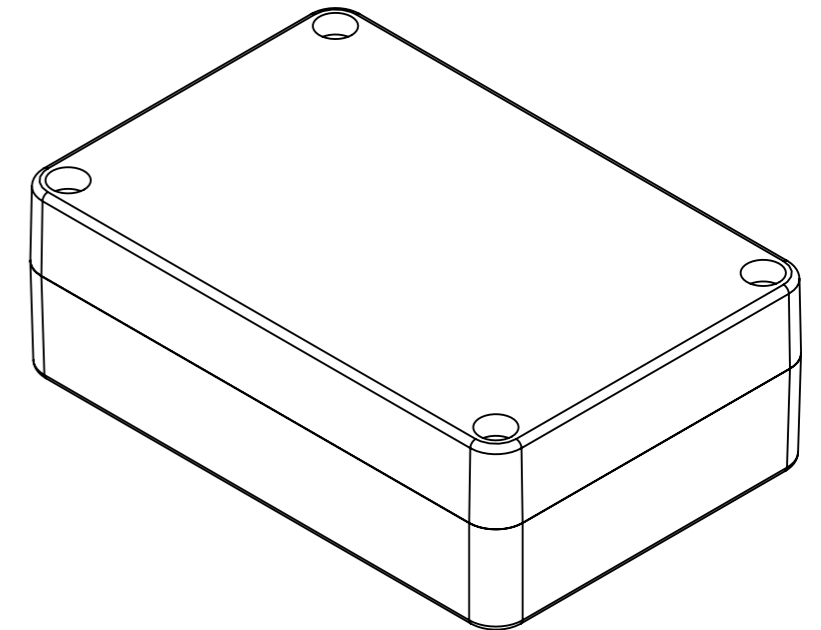
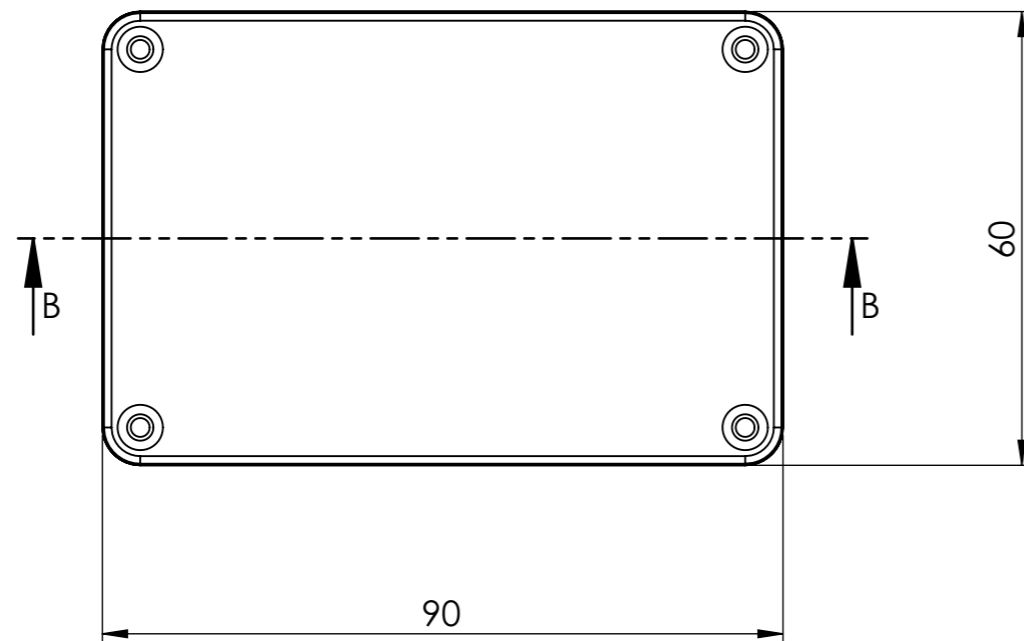

Tolerancja wymiarowa $\pm 0,3$ mm

Elementy składowe:
 - korpus
 - pokrywa
 - uszczelka
 - 4x wkręt

Format	Skala
A3	1:1
Nr Produktu	
KM-377	



MASZCZYK[®]
 OBUDOWY DLA ELEKTRONIKI

MASZCZYK sp. j.
 05-252 Małopole
 ul. Graniczna 24
 tel: +48 602-726-086 maszczyk@maszczyk.pl

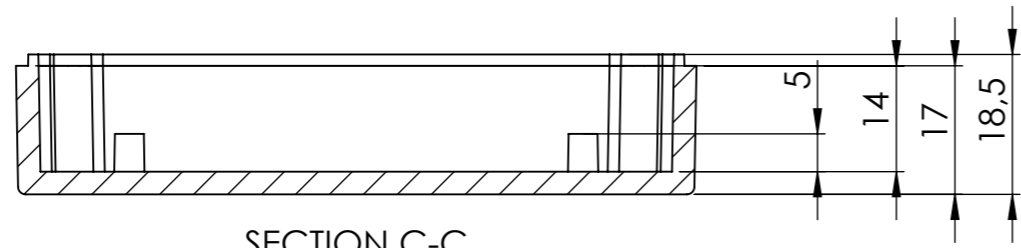

SECTION C-C

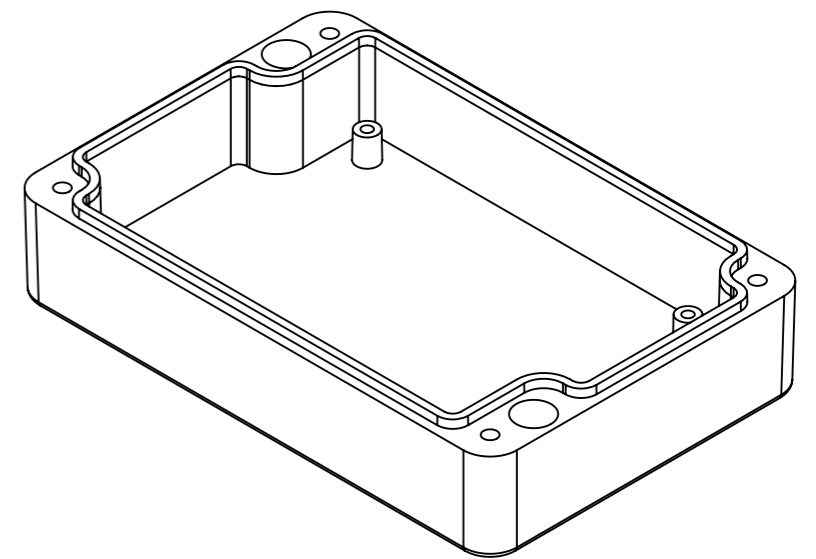
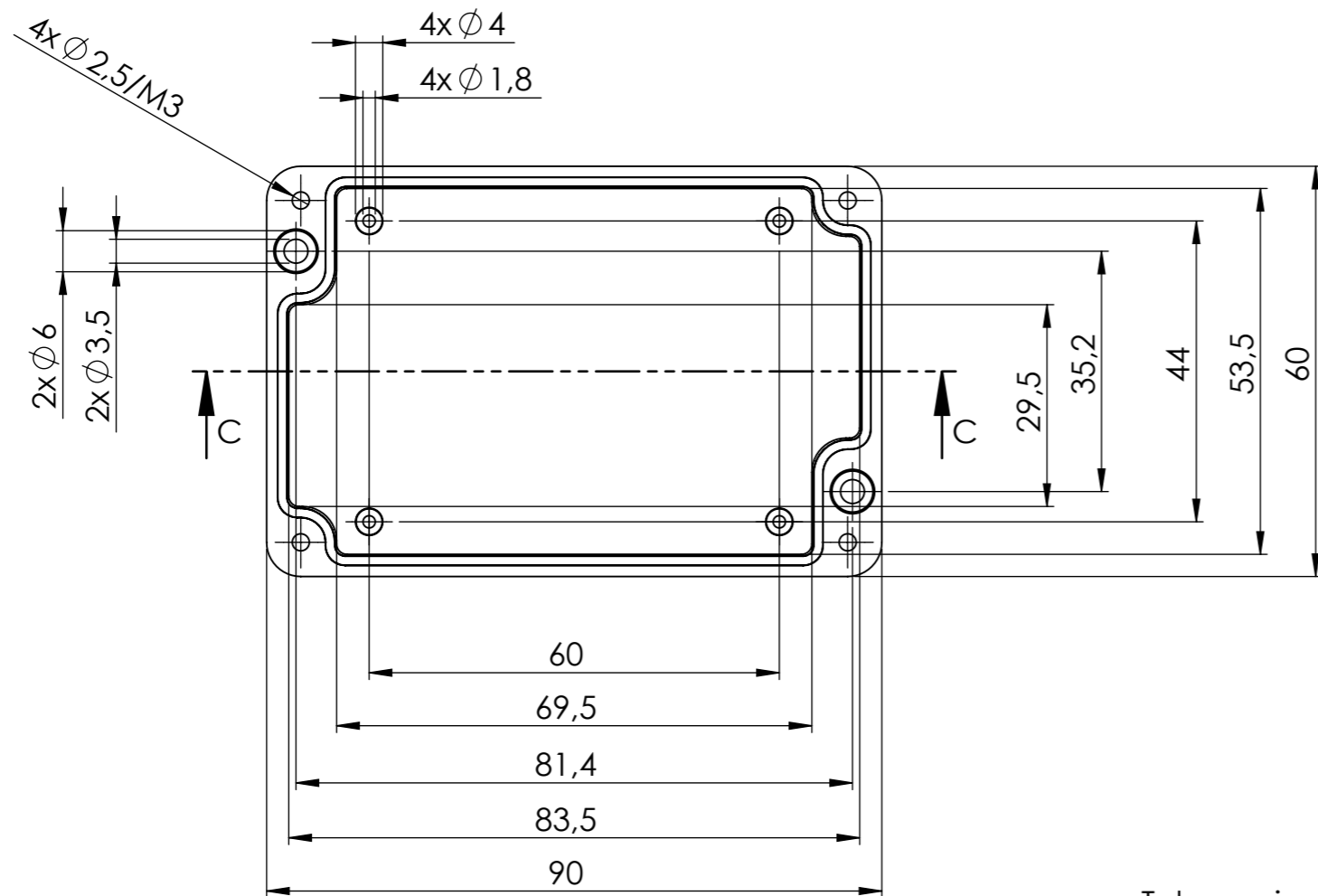

Tolerancja wymiarowa $\pm 0,3$ mm

Format	Skala
A3	1:1
Nr Produktu	
KM-377 (korpus)	



MASZCZYK®

OBUDOWY DLA ELEKTRONIKI

MASZCZYK sp. j.

05-252 Małopole

ul. Graniczna 24

tel: +48 602-726-086 maszczyk@maszczyk.pl



SECTION D-D

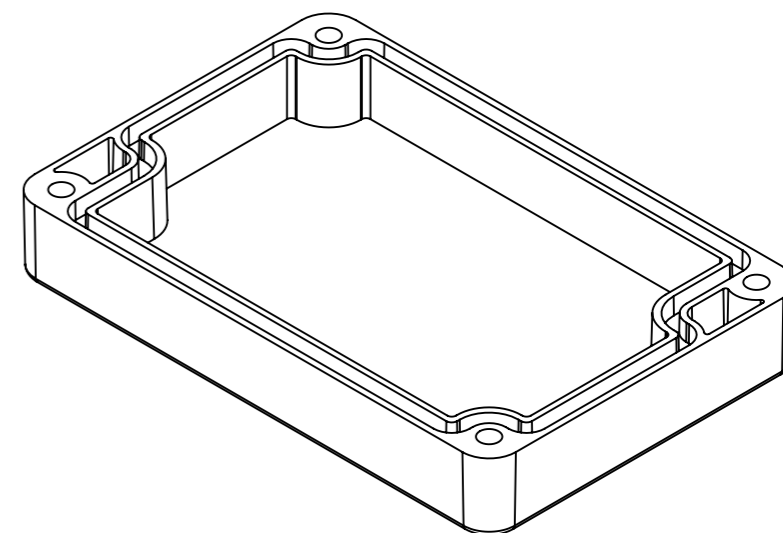
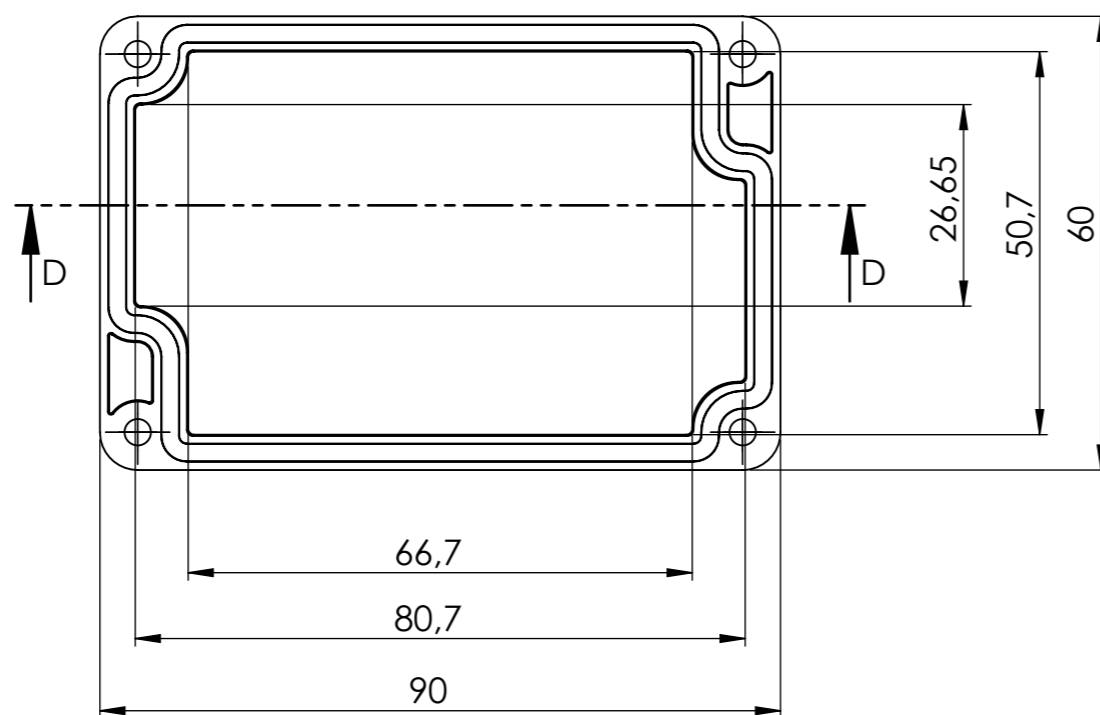

Tolerancja wymiarowa $\pm 0,3$ mm

Format	Skala
A3	1:1
Nr Produktu	
KM-377 (pokrywa)	



MASZCZYK[®]

OBUDOWY DLA ELEKTRONIKI

MASZCZYK sp. j.
05-252 Małopole
ul. Graniczna 24

tel: +48 602-726-086 maszczyk@maszczyk.pl